

eCatalogue

Shreya Construction Services



SHREYA CONSTRUCTION SERVICES

Retrofitting | Anchor fastener design & supply | Digital Quality process Consultant
Concrete Strengthening Solutions | Drilling & demolition (Heavy diamond)
Structural audit and repairs | MEP Installation Systems

web: <https://www.scscare.co.in>  @SCScareindia  @shreyaconstructionservices

CONSTRUCTION SERVICES

BY SHREYA CONSTRUCTION SERVICES

SPECIALISED IN DIGITAL PROCESS CONSULTANCY
AND RETROFITTING JOBS

ABOUT US



In 2022, Nitin Shahane, a chemical engineer from Mumbai University, founded Shreya Construction Services with the goal of providing quality and cost-effective services to the construction industry. 19+ prior experience in the construction field, technical know how and customer centricity, Nitin was determined to make Shreya Construction Services (SCS) the leading construction services company in India.

Nitin began by creating a unique business model that emphasized customer satisfaction. He associated with Construction digital quality process provider digiQC, retrofitting technocrats B-BAMS and worlds leading anchors and tools providers Rawlplug, with the team of highly qualified professionals from various disciplines who were passionate about their work.

Till now, Shreya Construction Services had become one of the most sought-after companies in construction projects. Our hard work and dedication had paid off and we are now firmly established as an industry leader.

WHAT DO WE DO?

1. Digital quality control process consultant
2. Chemical and mechanical anchor design, supply and installation
3. Diamond demolition
4. Structural steel work
5. Structural audit
6. Structural retrofitting
7. Construction MEP support system

OUR SERVICES

Top leading services we provide



Digital quality control is the most important thing today construction industry needs to save rework, intime project completion, remote approvals and increasing overall productivity. Paperless green technology, all project data on fingertips of management



Structural Audit and MEP audit is most important part of old buildings and increasing life of of the structures. One needs to be master in know how of structural aspects construction. B-BAMS team alongwith SCS look forward to create strong, reliable and long lasting structures in India

We provide anchor fastener design to save cost from undesired brands costing 2X-3X based on some influence. This saves end customers huge costing and can invest in better project resources to speed up project. eg. Post installed bars, Insert plate anchors, facade anchors, MEP anchors & support system

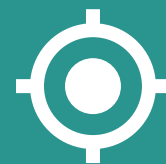

TARGET MARKET

Building construction, Infrastructure, Commercial, data centers, water treatment plant manufacturers, MEP Contractors, Facade contractors

Passive Rock Anchoring

We provide the best rock anchoring solution. We have Pure epoxy KEX-II chemical, with rock approval, and resistance against harmful chemicals inside the earth on reinforcement. We provide complete solution to rock anchoring and provide complete solution from embedment depth to layout

Installation System for utilities fixing

We provide the best rock anchoring solution. We have Pure epoxy KEX-II chemical, with rock approval, and resistance against harmful chemicals inside the earth on reinforcement. We provide complete solution to rock anchoring and provide complete solution from embedment depth to layout

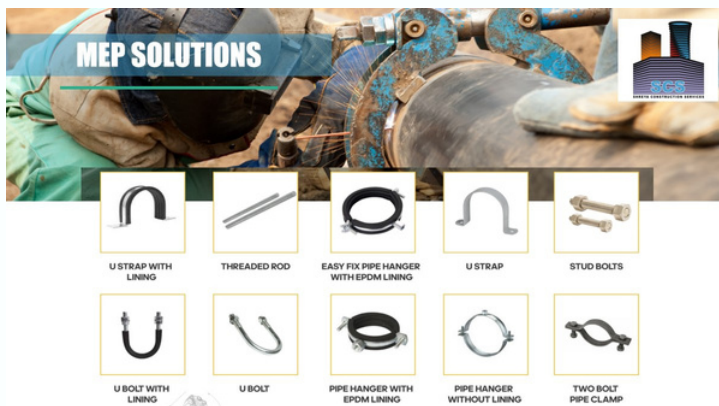

Click on photos for more details

Anchor system

Mechanical

Chemical

Post installed rebar

When it comes to connecting structural members there are multiple loading possibilities and it needs unique design. We provide optimum solution to your fixing so that it will be cost effective and not hit your pocket. we also provide all documentation needed to get approved from RCC consultant

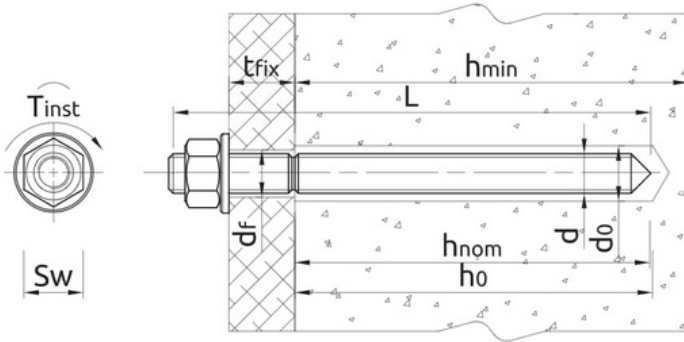

Installation guide

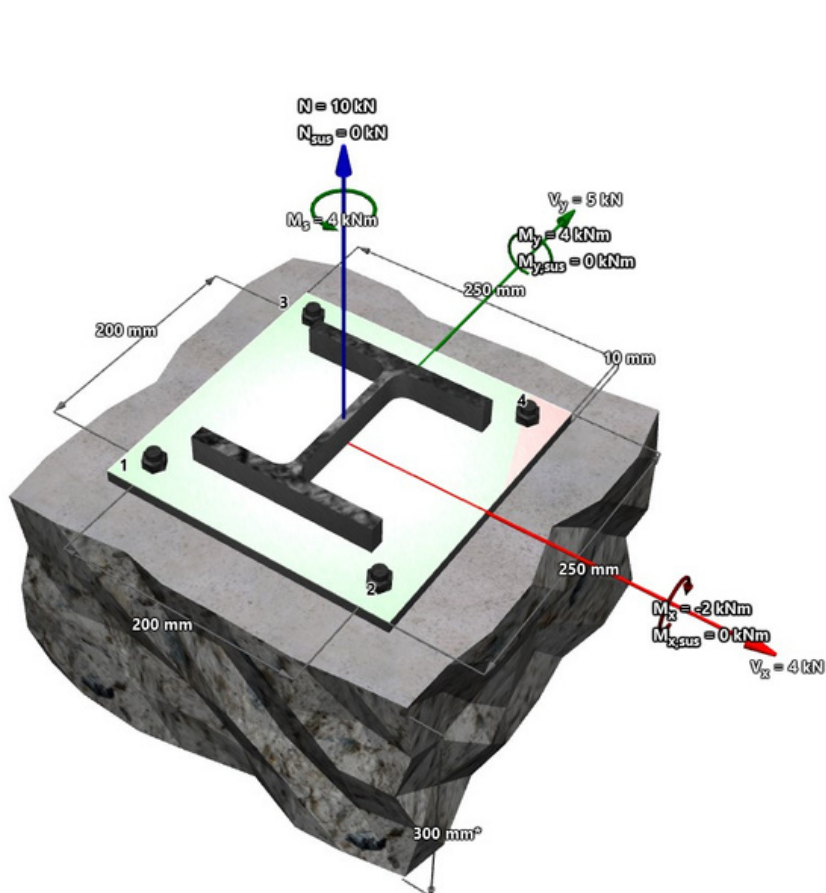
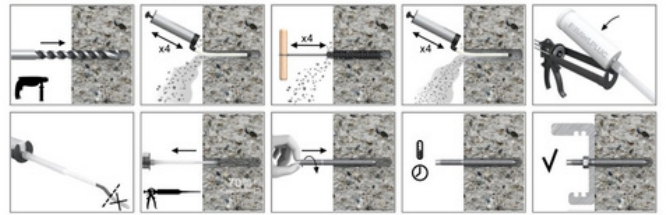

Retrofitting

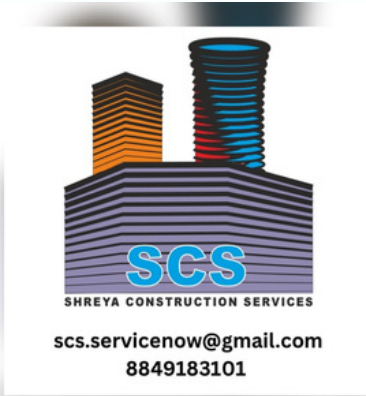

b-bams

Structural Strengthening

- Jacketing of columns
- Carbon Wrapping system
- Ratification of structure
- Waterproofing analysis
- Structural Audit
- Design and solution

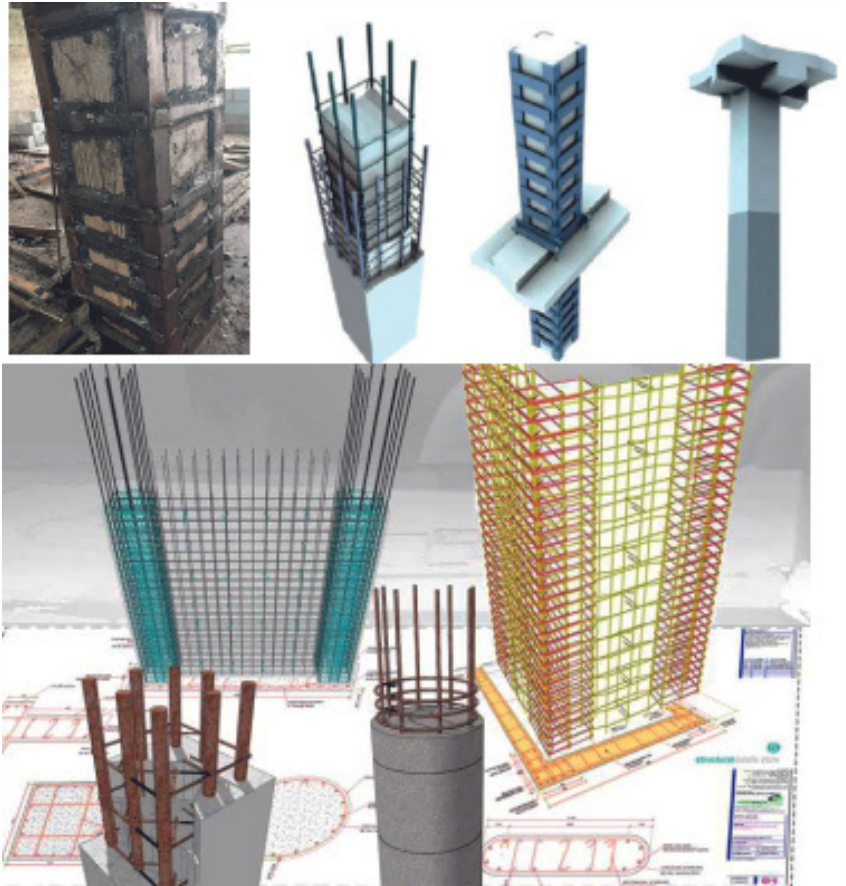

All this need expertise and getting work done from technocrats saves time and money by avoiding rework after certain age. Here we come into picture. We have our own designing team and multiple solution, which are cutting-edge solutions that are cost-effective, efficient, and reliable.

PRODUCTS

Click on the link below to explore available products and subscribe on website to stay updated

Explore products



Installation guide

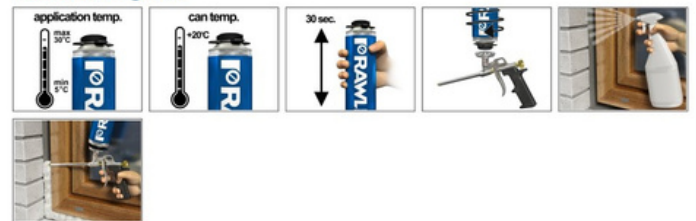

PRODUCTS

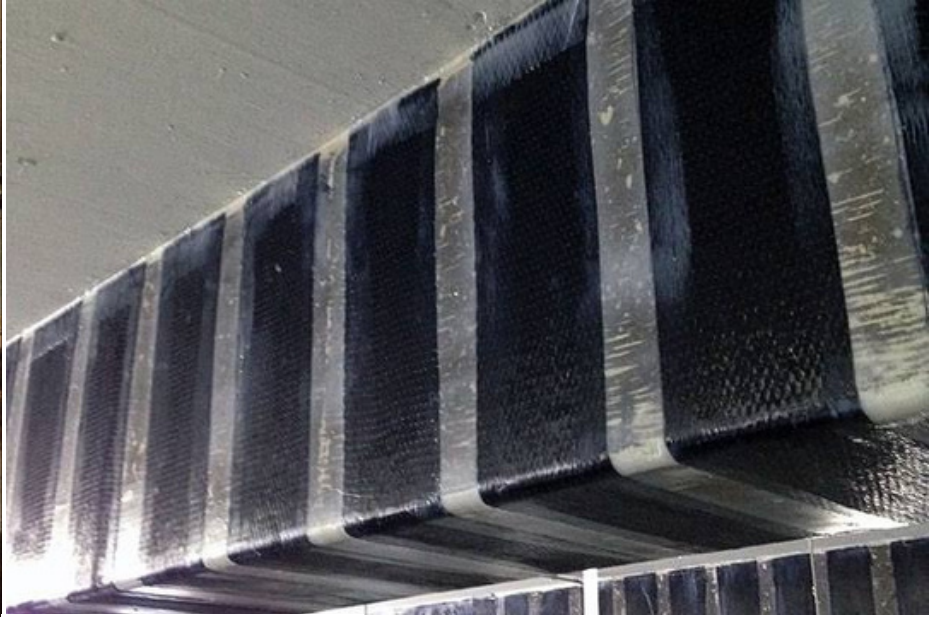

High Yield Polyurethane Gun Foam

PIANA
PISTOLETOWA
SUPER WYDAJNA

65L
wydajność

65L Yield



+

R-SC40-PCR Pipe and cable clip

+

R-SC40-PCO Pipe and cable plastic clip

+

R-SC40-PCD Double plastic clip

+

R-SC40-PCS Single plastic clip

+

R-SC40-CBD Double cable bow

+

R-SC40-CBS Single cable bow

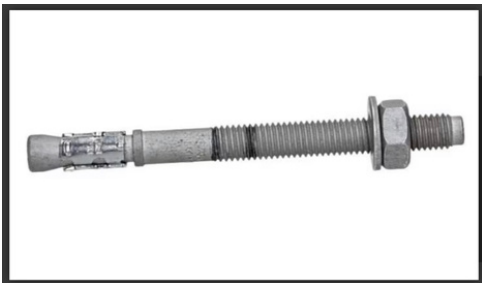

ETA CE

NYLON FRAME FIXING

- Collared plug for fixing of hard materials
- The stainless steel screw works wonder for very high loads
- 8.8 grade steel allows best performance
- This product is highly reliable when compared to its competitors

THANK YOU

We thank you for visiting our catalogue. We request you to share with relevant colleagues so that they can easily reach us. We also request you to subscribe on www.scscare.co.in to get latest updates and reach us at +91 [8048040484](tel:8048040484) or email us nitin@scacare.co.in. We ensure you our best products and services at all the times.

Visit us at : <https://www.scscare.co.in>

